

Technical data

CODE:

571104

PRODUCT:

LED MODULE DNH-4

NOTE:

TECHNICAL DATA

IMAGE:**LAST UPDATE:**

9/2021

LED MODULE DNH-4

2835 SMD	4 LEDs	230 V AC	IP 68	5 years
--------------------	------------------	--------------------	------------------------	-------------------

Model DNH-4

Features:

- Integrated high profile housing for easy installation and better light distribution
- Adopt brand LED as light source, high brightness, uniform color, good antistatic ability
- With 220-240 VAC 50/60 Hz, CC type, single led module can be cut, maximum 50 pcs per string
- Re-innovated lens technology with incredible 160° beam angle

Applications

Mainly used in 6-12 cm channel letters and lighting boxes etc.

Model	DNH-4
Operating voltage (V)	230 VAC 50/60 Hz
Power	1 W
Luminous flux	99 lm
Lightning effect	99lm/W @6500K
Beam angle	160°
Quantity of LED (pcs)	4 LEDs
Protection class	IP68
Dimension (mm)	57 x 16 x 10,5 mm
Color of the shell	white
Cascade Qty (pcs)	50 pcs
Fixing way	ST 2,5 x 10 mm
Back tape	3M foam tape
Operating temperature	-25~55°C
Storage temperature	-25~70°C
Warranty	5 years

**NO NEED POWER
SUPPLY!**

Profile drawings

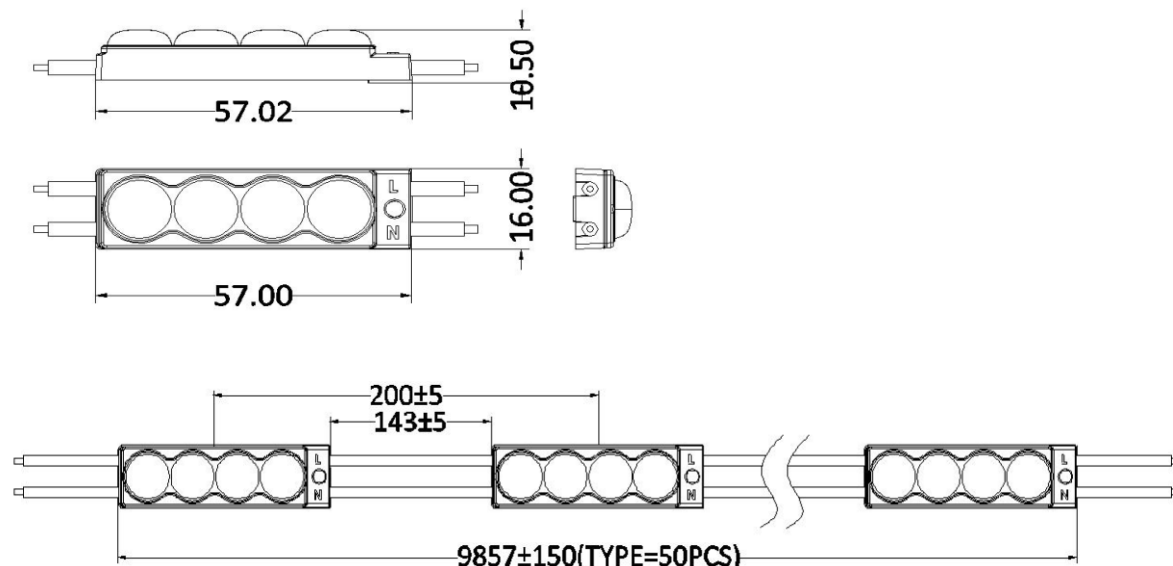

Packaging info:

Cascading/string	Bag/pcs	Carton/pcs	G.W/kgs	CTN/ dimension
50 pcs	50 pcs	500 pcs	7,9 kgs	45 x 25 x 26 cm