

Technical data

CODE:

571123

PRODUCT:

LED MODULE DNH-3

NOTE:

TECHNICAL DATA

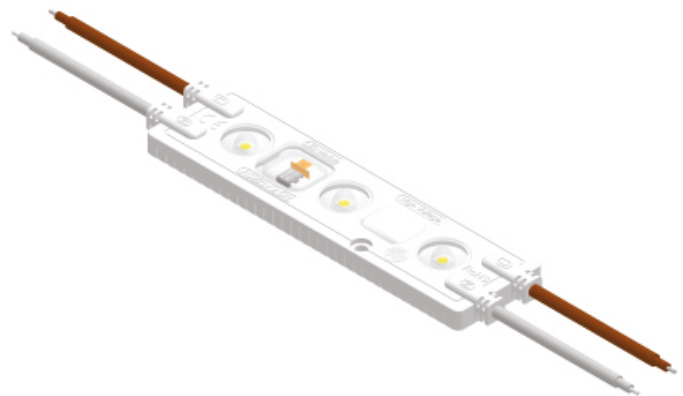
IMAGE:**LAST UPDATE:**

9/2021

LED MODULE DNH-3

CE	RoHS	2835 SMD	3 LEDs	230 V AC	IP 67	4 years
-----------	-------------	-----------------	---------------	-----------------	--------------	----------------

Model DNH-3

AC 220V Injection module - Terminator 2

Description:

- Adopt high quality LED as light source, high brightness, uniform lighting, good antistatic
- AC 220 - AC 240 V 50/60 Hz input; P.F>0,9
- Nice design with 155° optical lens
- Circuit design with constant current, over-temperature and short circuit protection function
- Use fire-resistant material, fireproof up to U94V-0 and waterproof up to IP67
- No need power supply; no wiring loss; no voltage-dropping single cuttable; easy installation
- Certificate: UL, CE, RoHS, LM80, IP67

Applications

Advertising sign with 100-350 mm and lighting box etc.

Warranty

4 years

Parameters of product	DNH-3
Voltage	AC 220 V - AC 240 V 50/60 Hz
Power	2,5 W
Lumens	200 lm
Beam angle	155°
PF	>0,9
LED qty	3 pcs
CCT	white
Luminous efficiency	80 lm/W
IP rate	IP67
Dimensions	110 x 28 x 8,5 mm
Cable	Double shield cables (18 AWG)
Material	ABS
Weight (50 pcs)	3 480 g
Connection qty	100 pcs/ string
Fixing screw	M3 screw
Tape	3M VHB tape
Working temperature	-20~55° C
Storage temperature	-20~70° C
Warranty	4 years

Parameters of light source	DNH-3
LED	CUSTOMIZED LED
Lifespan	> 35 000 Hrs
CRI	> 80
CCT	6 500 K

Lighting distribution curve

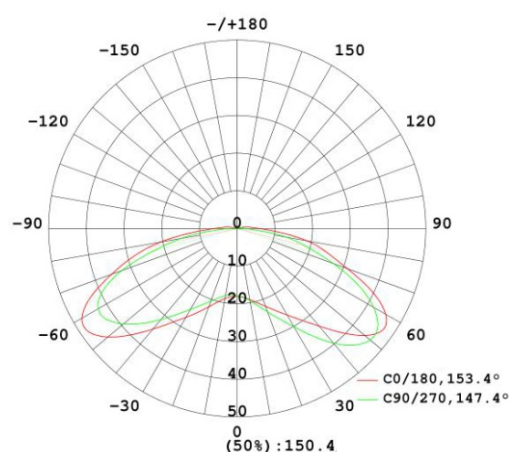

Lighting spot

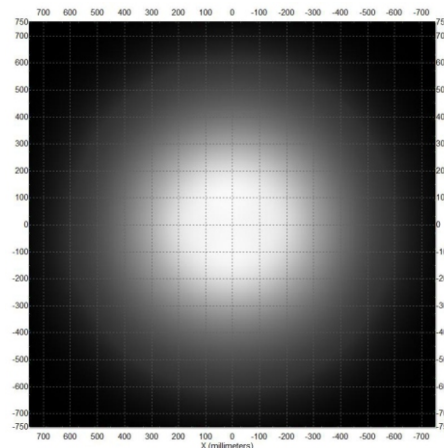

Dimension (mm)

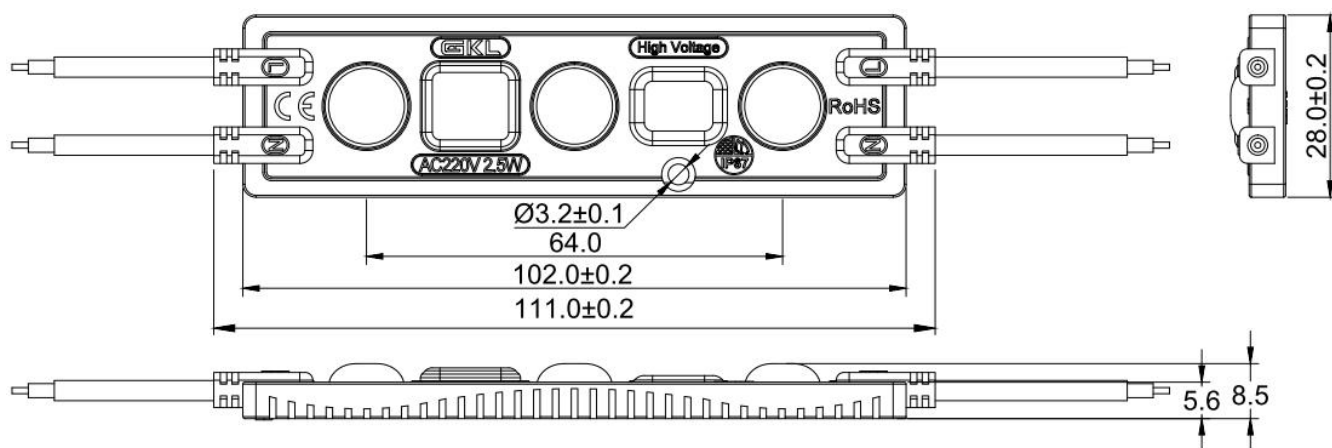

Installation and cable connecting diagram

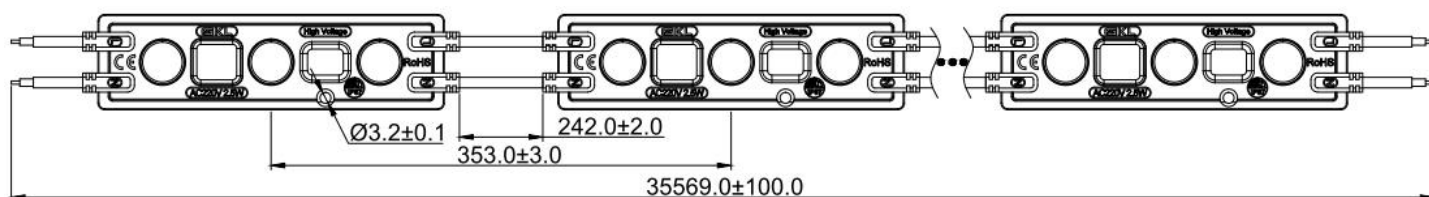

Solutions

Channel letter

Size of channel letter				Solution			
Width (A) (mm)	Depth (H) (mm)	Size (L*W) (mm)	Acreage (m ²)	Center distance (mm)	Total qty (pcs)	Installation density (pcs/m ²)	Lux range on surface(Lux)
130	120	1 060 * 665	0,7	230	12	17	2 500 - 3 000
152	150	1 225 * 770	0,94	270	16	16	2 600 - 3 200
203	200	1 650 * 1 125	1,86	300	28	15	2 000 - 2 600
253	250	2 012 * 1 430	2,88	320	40	14	1 500 - 2 000

Notes:

- The example channel letter with 3,00 mm acrylic plate and light transmittance of 54%
- The dimension of this channel letter: 640 x 750 mm
- Above data is just for reference

Light box

Depth (mm)	Center distance (mm)	Installation density (pcs/m ²)	Lux range on surface(Lux)
H = 100	dx = 200; dy = 140	32	3 200 - 3 800
H = 120	dx = 250; dy = 150	24	2 400 - 3 000
H = 150	dx = 250; dy = 220	18	2 000 - 2 300
H = 200	dx = 250; dy = 250	16	2 000 - 2 300
H = 250	dx = 300; dy = 270	12	1 200 - 1 600
H = 300	dx = 300; dy = 270	12	1 100 - 1 500

Notes:

- The example channel letter with 3,00 mm acrylic plate and light transmittance of 54%
- The dimension of this channel letter: 1 000 x 1 000 mm
- Above data is just for reference

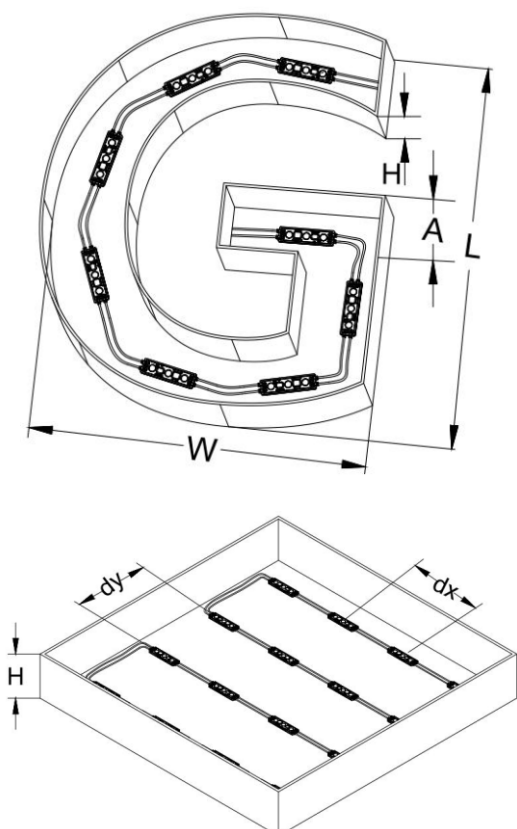

Packing

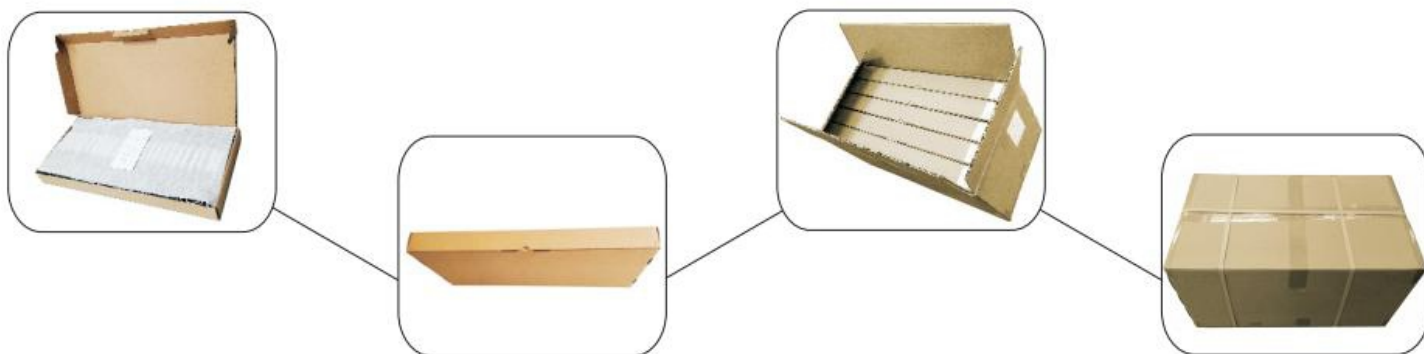

Notes:

100 pcs modules/ box; size 50 x 34 x 7 cm, GW 4 kgs

5 pcs boxes/ carton; size 53 x 38 x 36 cm, GW 22 kgs