

Technical data

CODE:

531324

PRODUCT:

LED MODULE D165-4

NOTE:

TECHNICAL DATA

IMAGE:**LAST UPDATE:**

8/2021

LED MODULE D165-4

CE	RoHS	2835 SMD	4 LEDS	Injection Lens	DC 12V	IP 65	5 years
-----------	-------------	-----------------	---------------	-----------------------	---------------	--------------	----------------

Model D165-4

4 pcs 2835 SMD LEDs, 45 x 38 x 6,6 mm, white shell, equipped with optical devices, injection series, 12 V DC, constant current, LED module

Features:

- Unique hard-edged shape, high-end and elegant
- 2835 SMD LED with low attenuation and long life
- Standard cascading qty up to 50 pcs
- Beam angle 160°
- Can be cut between every unit
- CE, RoHS compliant

Applications

Optimal for 8 - 30 cm depth channel letter

Warranty

5 years or 22 000 hours, whichever comes first

Model	D165-4
LED color	Pure white
CCT (K)	7000 K
CRI	≥ 75
SDCM	-
Beam angle	160°
Luminous flux	172 lm
Luminous efficacy	119 lm/W
Working voltage	12 VDC
Working current	120 mA
Power	1,44 W/ pcs
IP grade	IP65
Operating temperature °C	-25 ~ +60°C
Operating temperature °F	-13 ~ +140°F
Storage temperature °C	-25 ~ +70°C
Storage temperature °F	-13 ~ +158°F
Standard cascading qty	25 pcs
Single-ended max. cascading qty	25 pcs
Double-ended max. cascading qty	50 pcs
Weight (g/piece)	14,07 g/ pcs
Weight (lb/piece)	0,031 lb/ pcs

Notes:

- (1) Testing environment temperature: 25±2°C (77±3,6°F)
- (2) The actual data of each single product may differ from above typical data witch are subject to change without prior notice
- (3) The above „--“ means the parameters are not required temporarily

Profile drawings

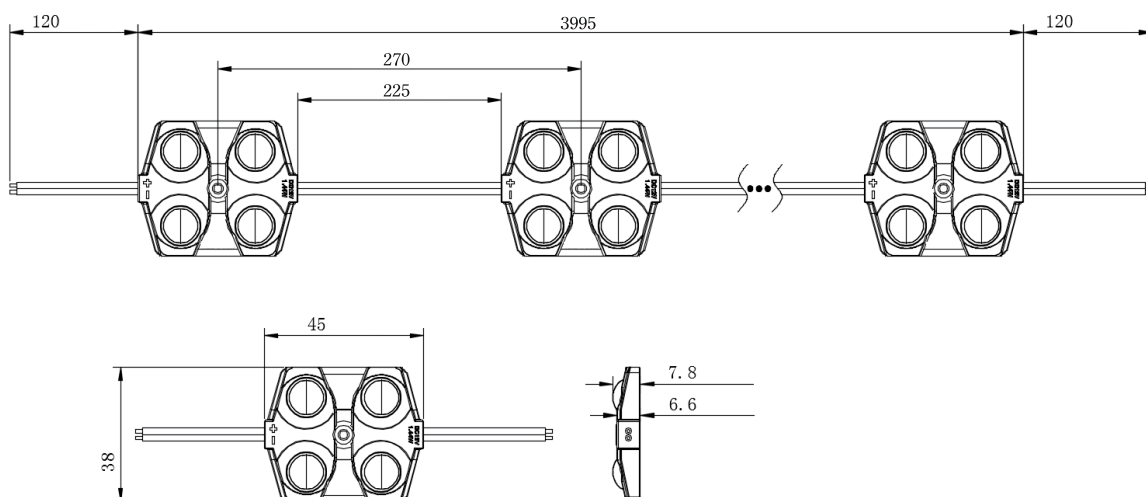

Light distribution

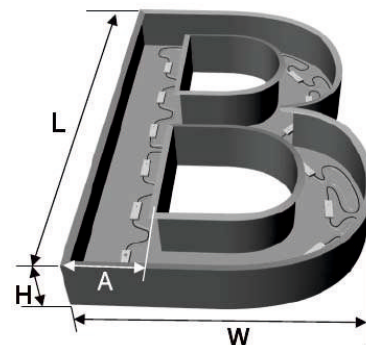
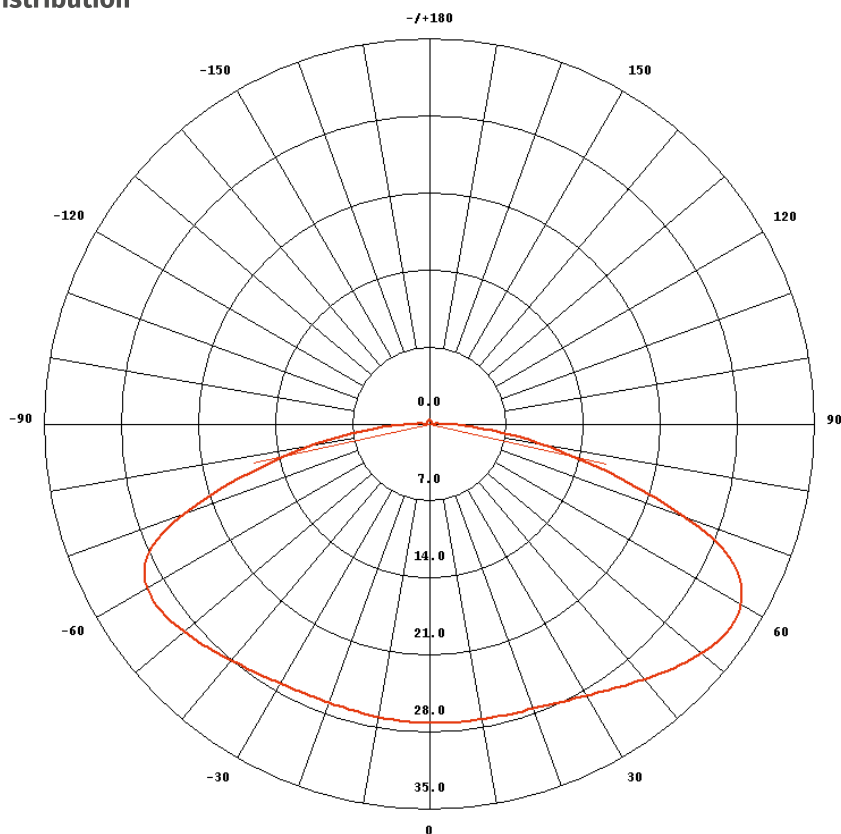

Layout data

Channel letter				LED Module			Surface illuminance range (lux)
Main width A (mm)	Main thickness H (mm)	Size L*W (mm)	Area (m ²)	Max. arrangement spacing (mm)	Total qty (pcs)	Installing density (pcs/m ²)	
85	80	650 x 320	0,14	130	12	86	5 800 - 6 800
115	100	850 x 425	0,25	155	14	56	4 300 - 4 700
140	120	1040 x 505	0,37	155	17	46	3 700 - 4 000

Notes

- (1) The above data is tested from the modules with color temperature of 6 500 K
- (2) The above light box uses acrylic white board with 3 mm depth and 54,4% light transmittance
- (3) The above illuminance is the minimum value tested on the even surface
- (4) The above data is for reference only

Packaging information

P/N	Qty (pcs/ bag)	Qty (bag/ carton)	Total qty (pcs)	Total weight		Length		Outer carton Width		Height	
				kg	lb	mm	inch	mm	inch	mm	inch
D165-4	50	18	900	14,74	32,4	528	20,78	376	14,8	272	10,7

Packaging diagram

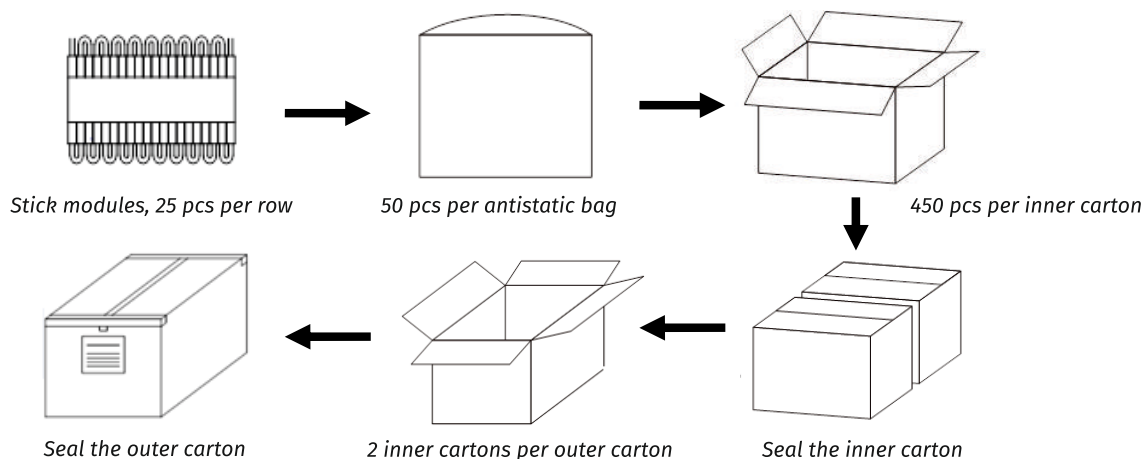

Connection instruction

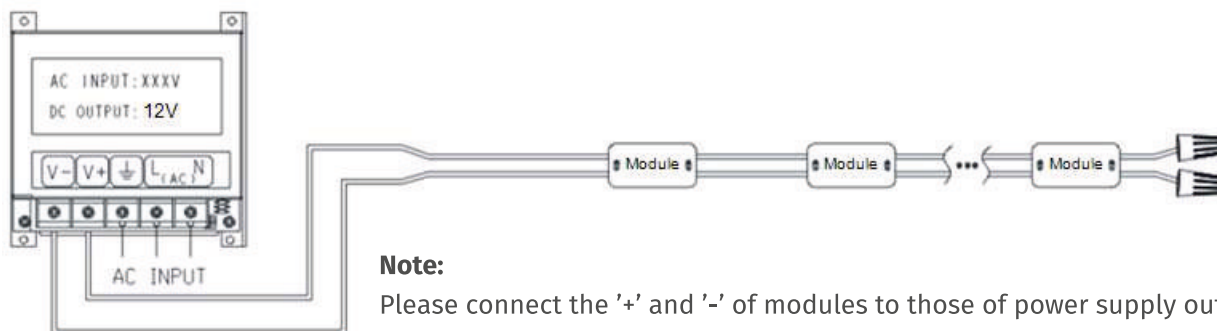

Note:

Please connect the '+' and '-' of modules to those of power supply output correctly.

Installation steps

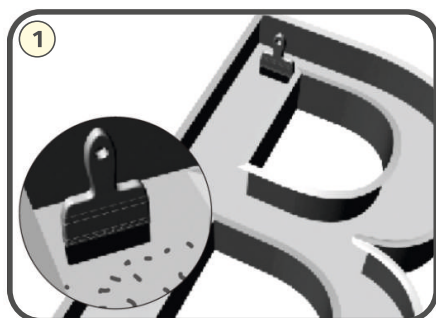

Clean the mounting surface

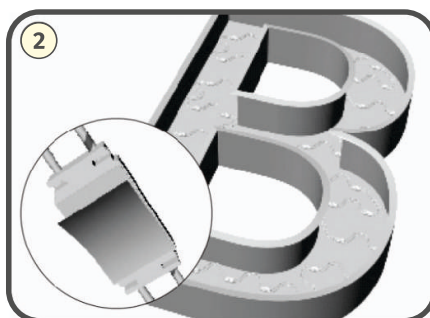

Peel off the release paper of double-sided adhesive tapes, then, stick modules on the installing surface for preliminary mounting

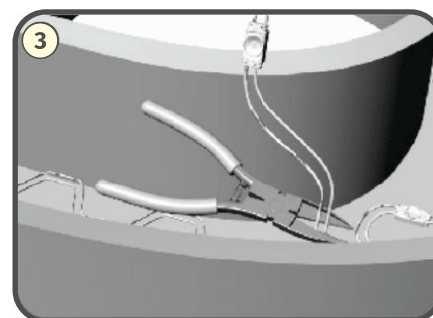

Cut off the modules to the desired qty, and peel off the insulation skin of wires about 10 mm
Note: Please cut from the middle of wires between modules

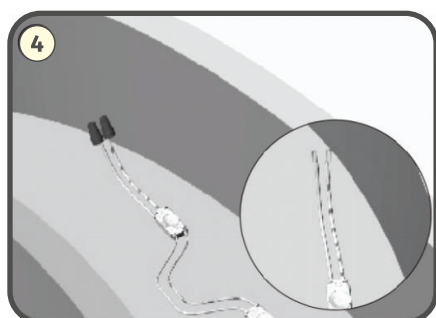

When the wires exposed on the last module, please peel off the insulation skin of wires about 10 mm each, then, screw in terminals respectively, and dispose with waterproof, insulation protection

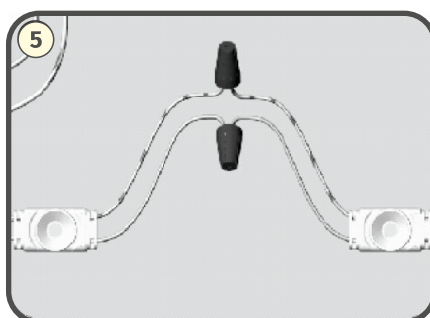

When connect the modules in series, peel off the insulation skin of wires of '+' and '-' about 10 mm each, then, screw in terminals respectively, and dispose with waterproof, insulation, anti-corrosion protection and short-circuit prevention

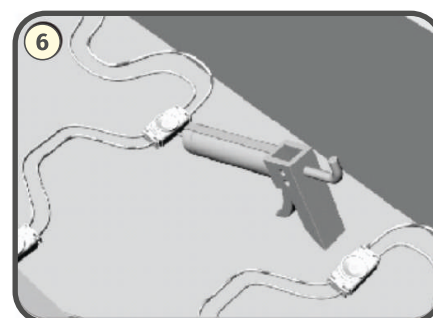

Adjust the modules to the best position, press the double-sided tape tightly and then fix by neutral glass glue
Note: The surface of modules, especially the position of LED, can't be covered by the neutral glass glue to avoid affecting product's performance

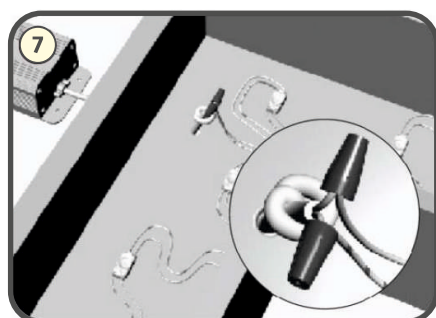

Please ensure that the '+' and '-' of the wires of modules are connected with those of power supply correctly, and dispose with waterproof, insulation, anti-circuit and anti-corrosion protection.

Troubleshooting

MALFUNCTIONS	POSSIBLE CAUSES	SOLUTIONS
All LEDs don't work	1. The power supply did not connect to power grid	Power on
	2. The electricity due to short-circuit of external power supply	Remove the malfunction caused by short-circuit, power on again
	3. The wires of module connect to power supply output reversely	Check the connecting and ensure the wires are connected correctly
Part of LEDs don't work	1. Part of power supplies do not have output	Check the power supply system
	2. Part of module wires have malfunction	
	3. Particular module connected reversely	Correct connection
Brightness of LEDs is weak or uneven	1. Overloaded power supply	Replace it with higher power supply
	2. The power loss of power circuit is huge or the power loss of each circuit existing big difference	Ensure working voltage of is within $\pm 5\%V$ of rated voltage 1. Shorten the length of wires between the first module and power supply or replaced with wires with bigger diameter; 2. Ensure the cascading qty of string is less than or equal to the allowed maximum cascading qty, and each module cascading qty is well-balanced
	3. Exceed in qty of modules in series	Lessen the cascading qty for module and ensure the qty for each electrical circuit is within the maximum cascading qty.
Brightness of LEDs is weak or uneven	1. Poor contacted in the joints	Find out and tackle malfunction immediately
	2. Failures in power supply	Replace power supply

Declaration

- If the external flexible cable of light box is damaged, please replace it by its manufacturer or its service agent or qualified person to avoid a hazard.
- The specific installation and cautions please refer to the user manual.
- The given data in this specification is based on our standard product. There may be existed slight difference compared with actual products.
- All Illustrations in this specification are for reference only.
- This product is subject to change or modify without prior notice.
- DENCOP reserves the right of final explanation for this specification.